

# Installing the S4820T System

Publication Date: January 2013



Force10

## Notes, Cautions, and Warnings

 **NOTE:** A NOTE indicates important information that helps you make better use of your computer.

 **CAUTION:** A CAUTION indicates either potential damage to hardware or loss of data and tells you how to avoid the problem.

 **WARNING:** A WARNING indicates a potential for property damage, personal injury, or death.

---

**Information in this publication is subject to change without notice.**

**© 2013 Dell Force10. All rights reserved.**

Reproduction of these materials in any manner whatsoever without the written permission of Dell Inc. is strictly forbidden.

Trademarks used in this text: Dell™, the DELL logo, Dell Precision™, OptiPlex™, Latitude™, PowerEdge™, PowerVault™, PowerConnect™, OpenManage™, EqualLogic™, KACE™, FlexAddress™ and Vostro™ are trademarks of Dell Inc. Intel®, Pentium®, Xeon®, Core™ and Celeron® are registered trademarks of Intel Corporation in the U.S. and other countries. AMD® is a registered trademark and AMD Opteron™, AMD Phenom™, and AMD Sempron™ are trademarks of Advanced Micro Devices, Inc. Microsoft®, Windows®, Windows Server®, MS-DOS® and Windows Vista® are either trademarks or registered trademarks of Microsoft Corporation in the United States and/or other countries. Red Hat Enterprise Linux® and Enterprise Linux® are registered trademarks of Red Hat, Inc. in the United States and/or other countries. Novell® is a registered trademark and SUSE™ is a trademark of Novell Inc. in the United States and other countries. Oracle® is a registered trademark of Oracle Corporation and/or its affiliates. Citrix®, Xen®, XenServer® and XenMotion® are either registered trademarks or trademarks of Citrix Systems, Inc. in the United States and/or other countries. VMware®, Virtual SMP®, vMotion®, vCenter®, and vSphere® are registered trademarks or trademarks of VMWare, Inc. in the United States or other countries.

Other trademarks and trade names may be used in this publication to refer to either the entities claiming the marks and names or their products. Dell Inc. disclaims any proprietary interest in trademarks and trade names other than its own.

# Contents

- 1 About this Guide
  - Information Symbols and Warnings . . . . . 7
  - Related Publications . . . . . 8
  
- 2 The S4820T Switch
  - Introduction . . . . . 9
  - Features . . . . . 10
  - Physical Dimensions . . . . . 10
  - Chassis Ports . . . . . 11
  - Determining System Status . . . . . 11
  - LED Displays . . . . . 11
  - Basic Installation Requirements . . . . . 14
  - Orderable S4820T Components . . . . . 15
  
- 3 Site Location and Preparation
  - Site Selection . . . . . 18
  - Cabinet Placement . . . . . 18
  - Rack Mounting . . . . . 18
  - Grounding . . . . . 18
  - Fans and Airflow . . . . . 18
    - Fan Combinations . . . . . 19
  - Power . . . . . 19
  - Storing Components . . . . . 19
  
- 4 Installing the S4820T
  - Unpacking the S4820T Switch . . . . . 21
    - Package Contents . . . . . 21
    - Unpacking Steps . . . . . 22
  - Installing Rack or Cabinet Hardware . . . . . 23
    - Rack Mounting Safety Considerations . . . . . 23
    - Installing the Dell ReadyRails System . . . . . 24
      - Two-post Flush-mount Configuration . . . . . 25
      - Two-post Center-mount Configuration . . . . . 26
      - Four-post Threaded Configuration . . . . . 27
  - Installing the S4820T Switch . . . . . 28
    - 1U Front-rack Installation . . . . . 28
    - Attaching the Ground Cable . . . . . 28
    - Installing an AC or DC Power Supply . . . . . 29
  - Installing QSFP+ Optics . . . . . 31

Removing QSFP+ Optics . . . . .	31
Splitting QSFP+ Ports to SFP+ or RJ-45 Ports . . . . .	31
Important Points to Know: . . . . .	31
Powering Up the S4820T Switch . . . . .	32
Power Up Sequence . . . . .	32
Connecting the Stacking Ports (Optional) . . . . .	33
Important Port-Stacking Points to Know . . . . .	33
Connect Two S4820T Systems . . . . .	34
Connect Three S4820T Systems . . . . .	35
Hot-Swapping Units in a Stack . . . . .	36
<b>5 Power Supplies</b>	
Components . . . . .	39
Installing an AC or DC Power Supply . . . . .	40
Replacing an AC or DC Power Supply . . . . .	40
Connecting a DC Power Supply to the Power Source . . . . .	41
Removing Power Connector from an S4820T DC Power Supply . . . . .	42
<b>6 Fans</b>	
Components . . . . .	43
Install a Fan Module . . . . .	44
Replace a Fan Module . . . . .	44
<b>7 Management Ports</b>	
Accessing the RJ-45 Console Port (RS-232) . . . . .	45
Default Configuration . . . . .	46
<b>8 Specifications</b>	
Chassis Physical Design . . . . .	47
Environmental Parameters . . . . .	47
Power Requirements . . . . .	48
AC Input Specification . . . . .	48
DC Input Specification . . . . .	48
IEEE Standards . . . . .	48
Agency Compliance . . . . .	49
Network Equipment Building Systems (NEBS) Compliance . . . . .	49
USA Federal Communications Commission (FCC) Statement . . . . .	49
Canadian Department of Communication Statement . . . . .	50
European Union EMC Directive Conformance Statement . . . . .	50
Japan: VCCI Compliance for Class A Equipment . . . . .	51

Korean Certification of Compliance . . . . . 51  
Safety Standards and Compliance Agency Certifications . . . . . 51  
Electromagnetic Compatibility (EMC) . . . . . 52  
Product Recycling and Disposal . . . . . 52

9 Technical Support





The iSupport Website . . . . . 55  
    Accessing iSupport Services . . . . . 55  
Contacting the Technical Assistance Center . . . . . 56  
Requesting a Hardware Replacement . . . . . 57





## About this Guide

This guide provides site preparation recommendations, step-by-step procedures for rack mounting and desk mounting, inserting optional modules, and connecting to a power source.

After you have completed the hardware installation and power-up of the S4820T, for software configuration information, refer to the *FTOS Configuration Guide for the S4820T System* and for Command Line Interface (CLI) information, refer to the *FTOS Command Line Reference Guide for the S4820T System*.

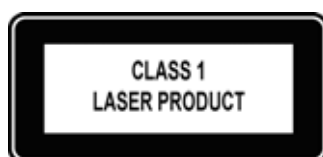
-  **NOTE:** User port stacking requires Dell Force10 Operating System (FTOS) version 8.3.19.0
-  **NOTE:** For information about upgrading the S4820T system, refer to the *FTOS Release Notes for the S4820T System*. If you have any questions regarding FTOS versions and system upgrades, contact Dell Force10 Technical Support.
-  **CAUTION:** To avoid electrostatic discharge (ESD) damage, wear grounding wrist straps when handling this equipment.
-  **WARNING:** Only trained and qualified personnel can install this equipment. Read this guide before you install and power up this equipment. This equipment may contain two power cords. Disconnect both power cords before servicing.
-  **WARNING:** This equipment contains optical transceivers, which comply with the limits of Class 1 laser radiation.





-  **WARNING:** When no cable is connected, visible and invisible laser radiation may be emitted from the aperture of the optical transceiver ports. Avoid exposure to laser radiation and do not stare into open apertures.



## Information Symbols and Warnings

This document uses the graphic symbols in [Table 1-1](#) to bring attention to hazards that exist when handling the S4820T and its components. Read these alerts and follow their warnings and cautions.

**Table 1-1. Information Symbols**

Symbol	Warning	Description
	Note	This symbol informs you of important operational information.
	Caution	This symbol indicates either potential damage to hardware or loss of data and tells you how to avoid the problem.

**Table 1-1. Information Symbols (continued)**

Symbol	Warning	Description
	Warning	This symbol informs you about hardware handling that could result in injury.
	ESD Warning	This symbol informs you that you must take electrostatic precautions when handling the device.

## Related Publications

For more information about the S4820T system, refer to the following documents:

- *FTOS Configuration Guide for the S4820T System*
- *FTOS Command Line Reference Guide for the S4820T System*
- *FTOS Release Notes for the S4820T System*



**NOTE:** For the most recent documentation and software, visit iSupport (registration for access to some sections is required): <http://www.force10networks.com/CSPortal20/Main/SupportMain.aspx>



## The S4820T Switch

This chapter contains general features, capabilities, and physical configurations supported by the S4820T. This chapter also contains a lists of optical and copper connectors that are supported by the S4820T, as well as a list of optional parts available for purchase.

### Introduction

S4820T is a top-of-rack (ToR) switch/router product for copper connections to 10Gbps servers and 40Gbps optical uplinks to the 40Gbps switching fabric in the core. The S4820T has 48 ports of RJ-45 10GBase-T and four ports of 40Gbps with features and functions similar to the S4810 product. The S4820T Power Supply Unit (PSU) side (Figure 2-1) contains the PSU, fan modules, and management ports. The S4820T Input/Output (I/O) side (Figure 2-2) contains the 48 10Gbps RJ-45 auto-sensing ports, four 40Gbps QSFP+ ports, a Universal Serial Bus port (USB), and stacking identification LEDs.

**Figure 2-1. S4820T PSU-Side View**

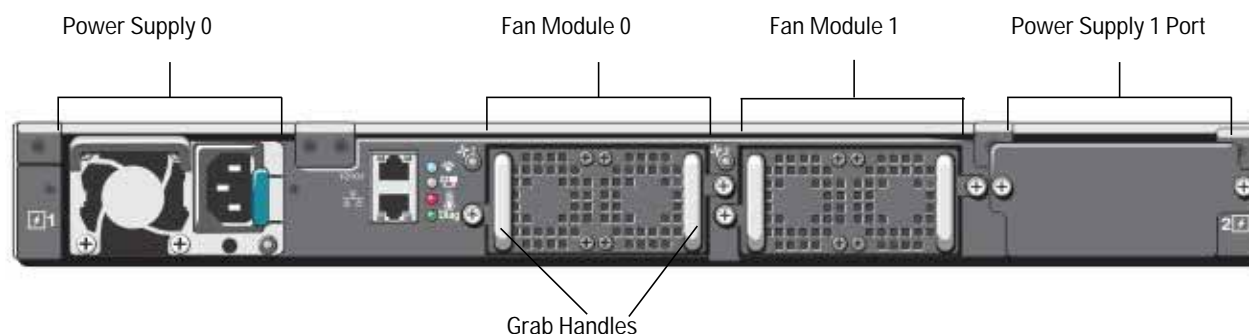

**Figure 2-2. S4820T I/O-Side View**

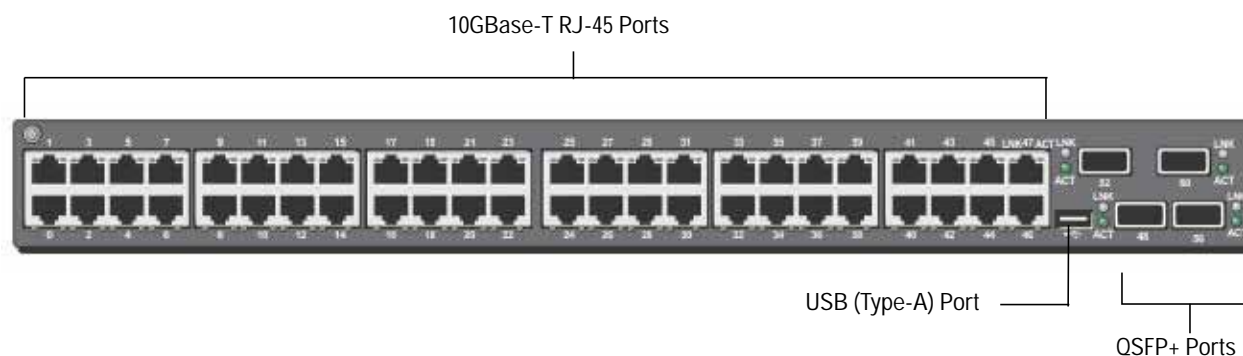

**NOTE:** The RJ-45 ports (Figure 2-2) are labeled 0-47. When you cable these ports, be sure not to interfere with the airflow from the small vent holes above and below the ports.

The S4820T switch runs the Dell Force10 Operating System (FTOS), providing switching, bridging, and routing functionality for transmitting data, storage, and server traffic.

In a data center network, the S4820T switch provides converged network support and inter-operates with Dell and third-party ToR devices. The switch supports data center bridging (DCB) features and optimizes connectivity between servers and storage devices using Fibre Channel over Ethernet (FCoE) and Internet Small Computer System Interface (iSCSI) links.

By providing increased 40GbE bandwidth for device interconnection in a shared network storage environment (with the possibility of splitting 40GbE Quad Small Form-Factor Pluggable Plus (QSFP+) uplinks into four 10GbE SFP+ or RJ-45 connections), the S4820T switch is perfectly positioned to help transition a data center with multiple speed requirements. Additionally, the S4820T solution is optimized to provide 10Gbps throughput for distances of up to:

- 330 feet (100 meters) over Cat6, 6A, and 7 shielded copper cable and Cat6A UTP copper cable
- 181.5 feet (55 meters) over Cat6 UTP copper cable

## Features

The S4820T has the following features:

- Forty-eight 1/10Gbps RJ-45 ports
- Four fixed 40Gbps QSFP+ ports for 40Gbps transceivers
- One universal serial bus (USB Type-A) port for additional file storage
- On-board high-performance central processing unit (CPU) system with large memory, P2020/128 MB NOR Flash/2GB DDR III RAM.
- Temperature monitoring (TMP75)
- Software-readable thermal monitor
- Real time clock (RTC) support
- Hot-plugging redundant power supply
- Current monitoring for Power management
- Removable fan that you can manage
- Standard 1U chassis high

## Physical Dimensions

The S4820T has the following physical dimensions:

- 434 x 460 x 43.5 mm (W x D x H).
- 17.09 x 18.11 x 1.71 inches (W x D x H).

# Chassis Ports

The following is a list of the standard ports located on each S4820T chassis:

- Serial RS-232 port (RJ-45 type)
- Out of band Ethernet management port (RJ-45 type)
- Forty-eight 1/10Gbps RJ-45 ports
- Four 40Gbps QSFP+ ports for four 40Gbps transceivers
- One Universal Serial Bus port (USB Type-A)

# Determining System Status

You can view S4820T status information in several ways, including Light Emitting Diodes (LEDs) and boot menu options. Also, you can view status information through the Command Line Interface (CLI) **show** commands and with Simple Network Management Protocol (SNMP) traps. For more information about these options, refer to the *FTOS Command Line Reference Guide for the S4820T System* and the *FTOS Configuration Guide for the S4820T System*.

# LED Displays

As shown in [Figure 2-1](#) and [Figure 2-2](#), the S4820T includes LED displays on the front and back of the chassis. [Figure 2-3](#) enumerates the S4820T chassis LEDs. See [Table 2-1](#) through [Table 2-4](#) provide a detailed description of each LED's meaning.

**Figure 2-3. Port LEDs**

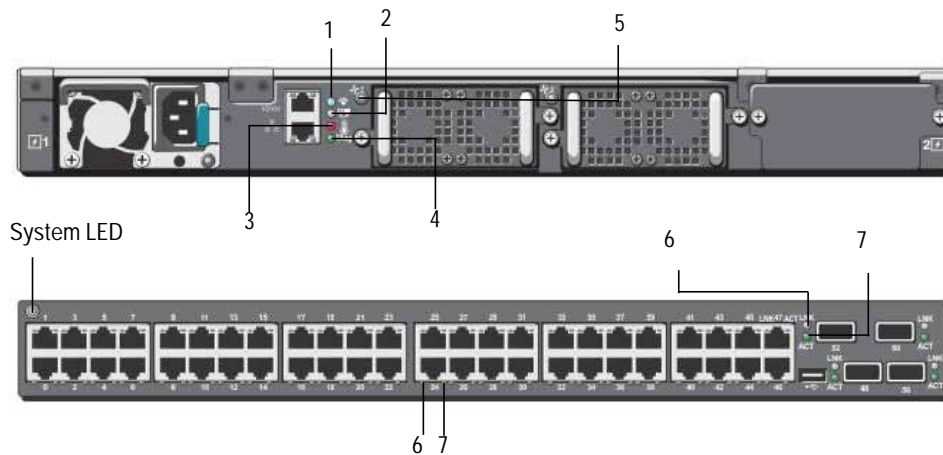

- 1 - Locator LED (Blue)
- 2 - Stack LED (Blue/Green)
- 3 - Temp LED (Red)
- 4 - Diag LED (Green)
- 5 - FAN LED (Green/Red)
- 6 - Link LED (Green/Amber)
- 7 - Activity LED (Blinking Green)

**Table 2-1. System LED Displays**

Feature	Detailed Description	Comment
System LED	<ul style="list-style-type: none"> <li>• Solid blue – Normal Operation</li> <li>• Blinking blue – Booting</li> <li>• Solid red – Critical system error</li> <li>• Blinking red – Non-critical system error (fan fail, power supply fail)</li> </ul>	I/O side
TEMP LED	<ul style="list-style-type: none"> <li>• Off: Normal temperature</li> <li>• Solid red – “Over-temp” (Refer to <a href="#">NOTE</a>: at bottom of table)</li> </ul>	PSU side
DIAG LED	<ul style="list-style-type: none"> <li>• Off – Normal operating</li> <li>• Solid green – System Booting or Diagnostics</li> </ul>	PSU side
FAN LED	<ul style="list-style-type: none"> <li>• Solid green – fan powered and running at the expected rpm</li> <li>• Solid red – fan failed</li> </ul>	PSU side
STACK LED	<ul style="list-style-type: none"> <li>• Solid blue – Switch in stacking master mode</li> <li>• Solid green– Switch in stacking slave mode</li> <li>• Off – Switch in stand alone mode</li> </ul>	PSU side
LOCATOR LED	<ul style="list-style-type: none"> <li>• Off – locator function is disabled</li> <li>• Solid blue – locator function is enabled</li> </ul>	PSU side

 **NOTE:** The system temperature threshold is 75°C. When one of the thermal sensors exceeds this temperature, the TEMP LED turns RED.

**Table 2-2. 10GBT Ethernet Port LEDs**

Feature	Detailed Description
Link LED	<ul style="list-style-type: none"> <li>• Off – No Link</li> <li>• Solid green – Link on 10Gbps speed</li> <li>• Solid Amber – Link on 100M or 1Gbps speeds</li> </ul>
Activity LED	<ul style="list-style-type: none"> <li>• Off – No Link</li> <li>• Blinking green – Transmit/Receive is active</li> </ul>

**Table 2-3. QSFP+ Port LEDs**

Feature	Detailed Description
Link LED	<ul style="list-style-type: none"> <li>• Off – No Link</li> <li>• Solid green – Link on 40Gbps speed</li> <li>• Solid Amber – Link on other speeds</li> </ul>
Activity LED	<ul style="list-style-type: none"> <li>• Off – No Link</li> <li>• Blinking green – Transmit/Receive is active</li> </ul>

**Table 2-4. Out of Band Ethernet Port LEDs**

Feature	Detailed Description
Link LED	<ul style="list-style-type: none"><li>• Off – No Link</li><li>• Solid green – Link on 1Gbps speed</li><li>• Solid Amber – Link on 100M or 10M speeds</li></ul>
Activity LED	<ul style="list-style-type: none"><li>• Off – No Link</li><li>• Blinking green – Transmit/Receive is active</li></ul>

## Basic Installation Requirements

Detailed installation instructions for the S4820T are provided in [Chapter 3, Site Location and Preparation](#) and [Chapter 4, Installing the S4820T](#), however, the following, is an initial list of components required for a successful installation of the S4820T:

- S4820T chassis (or multiple chassis, if stacking)
- If you ordered AC units, cables to connect the AC power source to each of the chassis' AC power supplies (country/regional configured)
- If you ordered DC units, cables to connect the DC power source to each of the chassis' DC power supplies
- Mounting brackets for rack installation (included)
- Screws for rack installation and #1 and #2 Phillips screwdrivers (not included)
- Ground cable (not included)
- Ground cable screws (included)
- Copper/fiber cables

Optional components for installation:

- Additional power supply units
- Additional fan modules
- Additional mounting brackets (if installing in a 4-post rack or cabinet)

# Orderable S4820T Components

You can order the S4820T system in several different configurations. Also, you can order optional modules and optics separately.

The Following is a list of different configurations, modules:

**Table 2-5. Supported Hardware Components**

Hardware
S4820T AC Normal Airflow: 48 port 10G RJ-45 ports with 4 QSFP+ 40G ports, 1 AC power supply and 2 fan subsystems (airflow from I/O side to power supply side)
S4820T AC Reverse Airflow: 48 port 10G RJ-45 ports with 4 QSFP+ 40G ports, 1 AC power supply and 2 fan subsystems (airflow from power supply side to I/O side)
S4820T AC Normal Airflow: 48 port 10G RJ-45 ports with 4 QSFP+ 40G ports, 1 DC power supply and 2 fan subsystems (airflow from I/O side to power supply side)
S4820T AC Reverse Airflow: 48 port 10G RJ-45 ports with 4 QSFP+ 40G ports, 1 DC power supply and 2 fan subsystems (airflow from power supply side to I/O side)
Fan with airflow from the I/O side to the PSU side
Fan with airflow from the PSU side to the I/O side
AC Power supply with airflow from the I/O side to the PSU side
AC Power supply with airflow from the PSU side to the I/O side
DC Power supply with airflow from the I/O side to the PSU side
DC Power supply with airflow from the PSU side to the I/O side





# Site Location and Preparation

The S4820T is suitable for installation as part of a Common Bond Network (CBN). It can be installed in:

- Network telecommunication facilities
- Data centers
- Other locations where the National Electric Code (NEC) applies

This chapter contains the following sections regarding where and how the S4820T should be installed:

- [Site Selection](#)
- [Cabinet Placement](#)
- [Rack Mounting](#)
- [Grounding](#)
- [Fans and Airflow](#)
- [Power](#)
- [Storing Components](#)

 **NOTE:** Install the S4820T system into a rack or cabinet before installing any optional components.

## Site Selection

Dell Force10 Networks' equipment is intended for installation in restricted access areas. A restricted access area is one in which access can only be gained by service personnel through the use of a special tool, lock, key or other means of security and access is controlled by the authority responsible for the location.

Make sure that the area where the S4820T system is installed meets all of the following safety requirements:

- Near an adequate power source. Connect the system to the appropriate branch circuit protection as defined by your local electrical codes.
- Environmental temperature between 32° to 104°F (0° to 40°C).
- Relative humidity that does not exceed 85% non-condensing.
- In a dry, clean, well-ventilated and temperature-controlled room, away from heat sources such as hot air vents or direct sunlight.
- Away from sources of severe electromagnetic noise.
- Positioned in a rack or cabinet, or on a desktop with adequate space in the front, rear, and sides of the S4820T for proper ventilation and access.

## Cabinet Placement

Install the S4820T only in indoor cabinets designed for use in a controlled environment as described in [Site Selection](#). Do not install the S4820T in outside plant cabinets.

The cabinet must meet the following criteria:

- Minimum cabinet size and airflow are according to the Electronic Industries Alliance (EIA) standard.

## Rack Mounting

When you prepare your equipment rack, ensure that the rack is earth ground. The equipment rack must be grounded to the same ground point used by the power service in your area. The ground path must be permanent.

## Grounding

Use the S4820T in a Common Bond Network (CBN). You must connect the grounding cables as described in [Chapter 4, Installing the S4820T](#).

## Fans and Airflow

The S4820T fans support two airflow options. Be sure to order the fans suitable to support your site's ventilation. Use a single type of airflow fan in your system. Do not mix reverse and normal airflows in a single S4820T chassis.

## Fan Combinations

The S4820T has stock keeping units (SKUs) that support the following configurations. Installation of the fans is done as part of the factory install based on SKU type.

- AC PSU with fan airflow from I/O to PSU
- AC PSU with fan airflow from PSU to I/O
- DC PSU with fan airflow from I/O to PSU
- DC PSU with fan airflow from PSU to I/O

All fans and PSUs in a configuration must be in the same airflow direction. Should a mixed airflow configuration happen, the software will notify you of the invalid configuration.

For proper ventilation, position the S4820T in an equipment rack (or cabinet) with a minimum of five inches (12.7cm) of clearance around the exhaust vents. When you install two S4820T systems near each other, position the two chassis at least five inches (12.7cm) apart to permit proper airflow. The fan speed increases when the internal temperature reaches 72°C and decreases to normal speed when the temperature falls to 58°C. The S4820T never intentionally turns off the fans.

Use the **show logging** command to see the log messages. For more information, refer to the System Logs chapters of the *FTOS Command Line Reference Guide for the S4820T System* and *FTOS Configuration Guide for the S4820T System*.

## Power

Use the appropriate power cord with the S4820T system to connect the chassis to the applicable power source.

- If the switch is an AC model, an AC power cord (country/region specific) is included with the system.
- If the switch is a DC model, a DC power cord (country/region specific) is included with the system.

When installing AC systems, follow the requirements of the National Electrical Code, ANSI/NFPA 70 where applicable.

The system is powered-up as soon as the power cord is connected between the system and the power source.

 **CAUTION:** Always disconnect the power cable before you service the power supply slots.

 **CAUTION:** Use the power supply cord as the main disconnect device on the AC system. Make sure that the socket-outlet is located/installed near the equipment and is easily accessible.

## Storing Components

If you do not install your S4820T and components immediately, Dell Force10 recommends properly storing the system and all optional components until you are ready to install them.

Follow these storage guidelines:

- Storage temperature must remain constant ranging from -4° to 158° F (-20°C to 70° C).

- Store on a dry surface or floor, away from direct sunlight, heat, and air conditioning ducts.
- Store in a dust-free environment.

 **WARNING:** Electrostatic discharge (ESD) damage can occur when components are mishandled. Always wear an ESD-preventive wrist or heel ground strap when handling the S4820T and its accessories. After you remove the original packaging, place the S4820T and its components on an antistatic surface.

# Installing the S4820T

To install the S4820T system, Dell Force10 recommends completing the installation procedures in the order presented in this chapter.

Always handle the S4820T and its components with care. Avoid dropping the system or its Field Replaceable Units (FRUs).

This chapter describes the installation procedures as follows:

- 1 [Unpacking the S4820T Switch](#)
- 2 [Installing Rack or Cabinet Hardware](#)
  - a [Installing the Dell ReadyRails System](#)
  - b [Two-post Flush-mount Configuration](#)
  - c [Two-post Center-mount Configuration](#)
  - d [Four-post Threaded Configuration](#)
- 3 [Installing the S4820T Switch](#)
  - a [1U Front-rack Installation](#)
  - b [Attaching the Ground Cable](#)
  - c [Installing an AC or DC Power Supply](#)
- 4 [Installing QSFP+ Optics](#)
- 5 [Connecting the Stacking Ports \(Optional\)](#)
- 6 [Powering Up the S4820T Switch](#)

 **WARNING:** Electrostatic discharge (ESD) damage can occur if components are mishandled. Always wear an ESD-preventive wrist or heel ground strap when handling the S4820T and its components. As with all electrical devices of this type, take all the necessary safety precautions to prevent injury when installing this system.

## Unpacking the S4820T Switch

 **NOTE:** Before unpacking the switch, inspect the container and immediately report any evidence of damage.

### Package Contents

When unpacking each S4820T switch, make sure that the following items are included:

- One S4820T switch
- One RJ-45 to DB-9 female cable
- Two sets of rail kits (no tools required)

- At least one PSU
- If an AC switch, at least one AC power cord (country/region specific)
- If a DC switch, at least one DC power cable
- *Getting Started Guide*
- *Safety and Regulatory Information*
- *Warranty and Support Information*
- *Software License Agreement*

## **Unpacking Steps**

- 1 Place the container on a clean, flat surface and cut all straps securing the container.
- 2 Open the container or remove the container top.
- 3 Carefully remove the switch from the container and place it on a secure and clean surface.
- 4 Remove all packing material.
- 5 Inspect the product and accessories for damage.

# Installing Rack or Cabinet Hardware

You may either place the switch on the rack shelf or mount the switch directly into a 19" wide, EIA-310-E-compliant rack (four-post, two-post, or threaded methods). The Dell ReadyRails™ system is provided for one 1U front-rack, and two-post installations. The ReadyRails system includes two separately packaged rail assemblies and two rails that are shipped attached to the sides of the switch.

 **WARNING:** This is a condensed reference. Read the safety instructions in your Safety, Environmental, and Regulatory information booklet before you begin.

 **NOTE:** The illustrations in this document are not intended to represent a specific switch.

## Rack Mounting Safety Considerations

- Rack loading—Overloading or uneven loading of racks may result in shelf or rack failure, causing damage to the equipment and possible personal injury. Stabilize racks in a permanent location before loading begins. Mount the components beginning at the bottom of the rack, then work to the top. Do not exceed your rack load rating.
- Power considerations—Connect only to the power source specified on the unit. When multiple electrical components are installed in a rack, ensure that the total component power ratings do not exceed the circuit capabilities. Overloaded power sources and extension cords present fire and shock hazards.
- Elevated ambient temperature—If installed in a closed rack assembly, the operating temperature of the rack environment may be greater than the room ambient temperature. Use care not to exceed the 40°C maximum ambient temperature of the switch.
- Reduced air flow—Install the equipment in the rack so that the amount of airflow required for safe operation of the equipment is not compromised.
- Reliable earthing—Maintain reliable earthing of rack-mounted equipment. Pay particular attention to the supply connections other than the direct connections to the branch circuit, for example: use of power strips.
- Do not mount the equipment with the rear panel facing in the downward position.

## Installing the Dell ReadyRails System

The ReadyRails rack mounting system is provided to easily configure your rack for installation of your S4820T switch. The ReadyRails system can be installed using the 1U tool-less method or one of three possible 1U tooled methods (two-post flush mount, two-post center mount, or four-post threaded).

- 1 With the ReadyRails flange ears facing outward, place one rail between the left and right vertical posts. Align and seat the rear flange rail pegs in the rear vertical post flange. In [Figure 4-1](#), step 1 and its extractions show how the pegs appear in both the square and non-threaded round holes.

**Figure 4-1. 1U Tool-less Configuration**

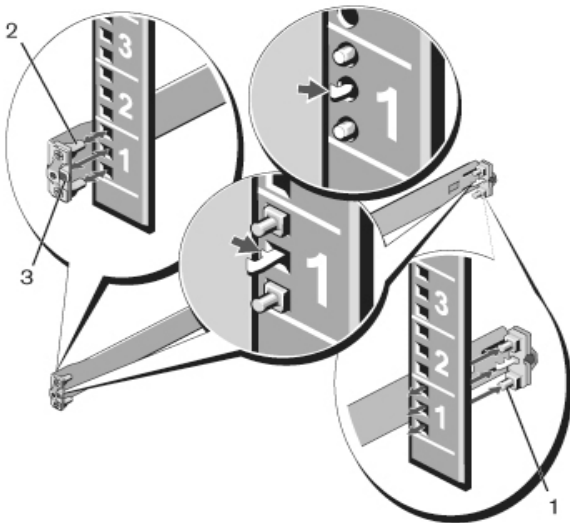

- 2 Align and seat the front flange pegs in the holes on the front side of the vertical post. Refer to [Figure 4-1](#), step 2.
- 3 Repeat this procedure for the second rail.
- 4 To remove each rail, pull on the latch release button on each flange ear and unseat each rail. Refer to [Figure 4-1](#), step 3.



## Two-post Flush-mount Configuration

- 1 For this configuration, you must remove the castings from the front side of each ReadyRails assembly. Refer to [Figure 4-2](#), step 1. Use a Torx driver to remove the two screws from each front flange ear (on the switch side of the rail) and remove each casting. Retain the castings for future rack requirements. It is not necessary to remove the rear flange castings.

**Figure 4-2. Two-post Flush-mount Configuration**

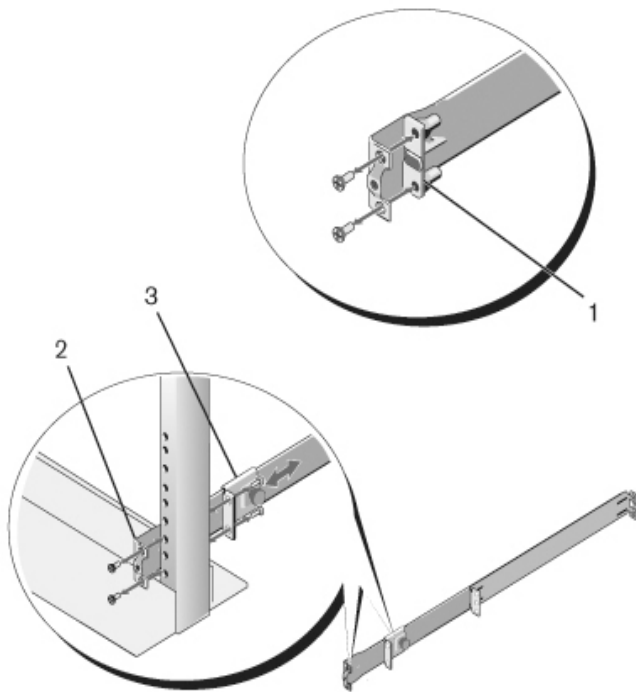

- 2 Attach one rail to the front post flange with two user-supplied screws. Refer to [Figure 4-2](#), step 2.
- 3 Slide the plunger bracket forward against the vertical post and secure the plunger bracket to the post flange with two user-supplied screws. Refer to [Figure 4-2](#), step 3.
- 4 Repeat this procedure for the second rail.

## Two-post Center-mount Configuration

- 1 Slide the plunger bracket rearward until it clicks into place and secure the bracket to the front post flange with two user-supplied screws. Refer to [Figure 4-3](#), step 1.

**Figure 4-3. Two-post Center-mount Configuration**

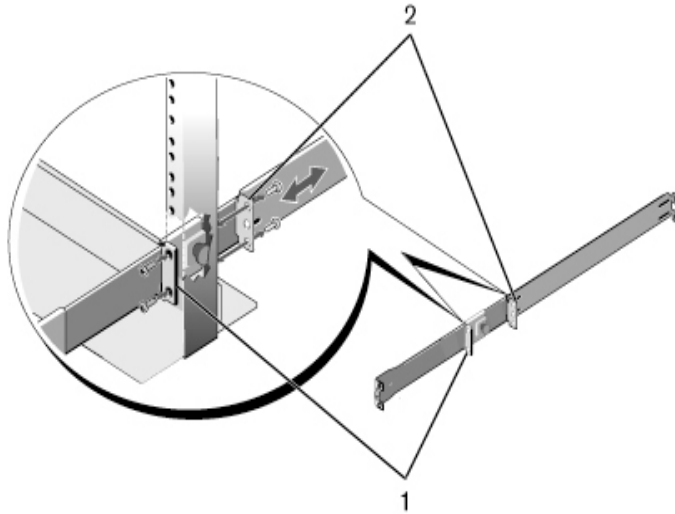

- 2 Slide the back bracket towards the post and secure it to the post flange with two user-supplied screws. Refer to [Figure 4-3](#), step 2.
- 3 Repeat this procedure for the second rail.

## Four-post Threaded Configuration

- 1 For this configuration, you must remove the flange ear castings from each end of the ReadyRails assemblies. Use a Torx driver to remove the two screws from each flange ear and remove each casting. Refer to [Figure 4-4](#), step 1. Retain the castings for future rack requirements.
- 2 For each rail, attach the front and rear flanges to the post flanges with two user-supplied screws at each end. Refer to [Figure 4-4](#), step 2.

**Figure 4-4. Four-post Threaded Configuration**

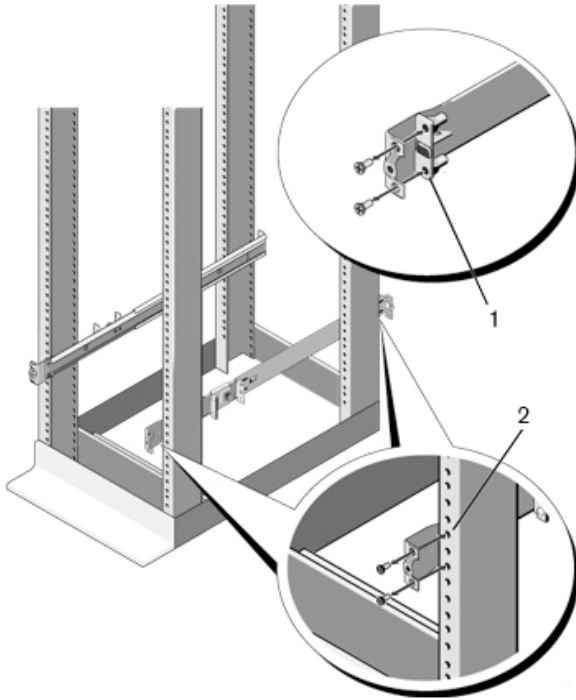

## Installing the S4820T Switch

You can mount the switch in the 1U front-rack or 1U two-post (flush and center) configurations. The following is an example of a front-rack configuration. For the 1U two-post (flush and center) configurations, you can slide the switch into the rails in the same manner as the four-post configurations.

### 1U Front-rack Installation

You must configure the rails that are attached to the switch.

- 1 Attach the switch rails (inner chassis members) to the S4820T switch. [Figure 4-5](#), step 1 shows the detail for the front standoff with the locking tab.

**Figure 4-5. Attaching the Switch Rails**

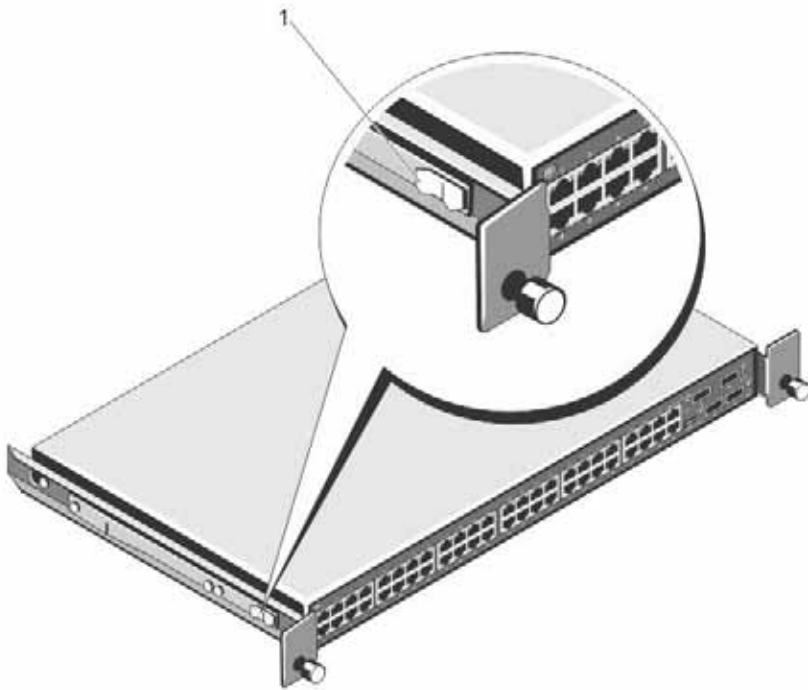

- 2 After both switch rails are installed, line them up on the previously mounted Ready-Rails and slide the switch in until it is flush with front of rack. About three inches prior to full insertion, the rail locking feature engages to keep the switch from inadvertently sliding out of the rack and falling.

### Attaching the Ground Cable

Use a single M4x0.7 screw to attach the ground cable to the chassis. The cable itself is not included with the S4820T. To properly ground the chassis, Dell Force10 recommends using a 6AWG one-hole lug, #10 hole size, 63" spacing (not included in shipping). The one-hole lug must be a UL recognized, crimp-type lug.

To connect the ground cable to the system, follow these steps:

**NOTE:** The rack installation “ears” are not suitable for grounding.

**CAUTION:** Grounding conductors *must* be made of copper. Do not use aluminum conductors.

- ✎ **NOTE:** Coat the one-hole lug with an anti-oxidant compound prior to crimping. Also, bring any un-plated mating surfaces to a shiny finish and coat with an anti-oxidant prior to mating. Plated mating surfaces must be clean and free from contamination.
- 1 Take the one M4x0.7 screw from the package.
  - 2 Cut the cable to the desired length. The cable length must facilitate proper operation of the fault interrupt circuits. Dell Force10 recommends using of the shortest cable route allowable.
  - 3 Attach the one-hole lug to the chassis using the supplied 10-32 screw with the captive internal tooth lock washer. Torque the screw to 20 in-lbs.
  - 4 Attach the other end of the ground cable to a suitable ground point. The rack installation ears are not a suitable grounding point.

## Installing an AC or DC Power Supply

The S4820T supports two hot-swappable power supplies units (PSUs) and fans that provide cooling for the system. The S4820T supports AC and DC power supplies with two air-flow directions (I/O to PSU or PSU to I/O). Two PSUs are required for full redundancy, but the system will operate with a single PSU.

- ✎ **NOTE:** If you use a single PSU, you must install a blank plate in the other PSU slot. Dell Force10 recommends using power supply 1 (PSU1) as the blank plate slot.

The PSUs are field replaceable. When running with full redundancy (two power supplies installed and running), you can remove and replace one PSU while the other PSU is running without disrupting traffic.

The S4820T does not support mixing PSU types. You cannot replace an AC PSU with a DC PSU and you cannot replace an AC-R PSU with a DC-R PSU.

- ⚠ **WARNING:** Electrostatic discharge (ESD) damage can occur if components are mishandled. Always wear an ESD-preventive wrist or heel ground strap when handling the S4820T and its components.

- ⚠ **CAUTION:** To prevent electrical shock, ensure the S4820T is grounded properly. If you do not ground your equipment correctly, excessive emissions may result. Use a qualified electrician to ensure the power cables meet your local electrical requirements.

**Figure 4-6. S4820T Power Supply**



- ✎ **NOTE:** The PSU slides into the slot smoothly. Do not force a PSU into a slot as this may damage the PSU or the S4820T chassis.
- ✎ **NOTE:** Ensure that the PSU is correctly installed. When the PSU is correctly installed, the power connector is on the right side of the PSU and the status LED is at the top of the PSU
- ✎ **NOTE:** If you use a single PSU, you must install a blank plate in the other PSU slot. Dell Force10 recommends using power supply 1 (PSU1) as the blank plate slot.

To install an AC or DC power supply, follow these steps:

- 1 Remove the PSU slot cover from the S4820T (PSU side of switch), either of the two PSU slots may be selected.
- 2 Remove the PSU from the electrostatic bag.
- 3 Insert the PSU into the switch PSU slot (PSU exposed PCB edge connector should be inserted first). The PSU slot is keyed such that the PSU can only be fully inserted in one orientation. When the PSU is installed correctly it should snap into place and be flush with the back of the switch.
- 4 Plug in the appropriate cord (AC 3 prong or DC wiring) from the switch PSU to the external power source (either AC wall outlet or DC rack bus bar).
- 5 If you have a redundant PSU (2nd PSU), repeat steps 1 through 5 above using the 2nd PSU slot on the S4820T switch.

 **NOTE:** The system powers up as soon as the cables are connected between the power supply and the power source.

## Installing QSFP+ Optics

The S4820T has four QSFP+ optical ports. For supported optics, refer to <http://www.force10networks.com/products/specifications.asp>.

 **WARNING:** ESD damage can occur if components are mishandled. Always wear an ESD-preventive wrist or heel ground strap when handling the S4820T and its components.

 **WARNING:** When working with optical fibers, follow all warning labels and always wear eye protection. Never look directly into the end of a terminated or unterminated fiber or connector, which may cause eye damage.

To install QSFP+ optics into an open port, follow these steps:

- 1 Position the optic so it is in the correct position. The optic has a key that prevents it from being inserted incorrectly.
- 2 Insert the optic into the port until it gently snaps into place.

 **NOTE:** Both rows of QSFP+ ports require that the 40G optics be inserted with the tabs facing up.

## Removing QSFP+ Optics

Remove an optic by pushing the tab on the optic and sliding the optic from the port.

When removing optics with Direct Attach Cables (DACs) from the port, pull the release tab firmly and steadily. Prior to pulling the release tab, you may need to gently push the optic into the port to ensure it is seated properly. Do not jerk or tug repeatedly on the tab.

## Splitting QSFP+ Ports to SFP+ or RJ-45 Ports

The S4820T supports splitting a single 40G QSFP+ port into four 10G SFP+ ports or four 10G RJ-45 ports using one of the supported breakout cables.

For the system to recognize the port type change, you must enter the **stack-unit portmode** command.

For example:

```
stack-unit stack-unit port number portmode quad
```

- *stack-unit*: Enter the stack member unit identifier of the stack member to reset. Range: 0 - 11.
- *number*: Enter the port number of the 40G port to be split. Range:0-31.

## Important Points to Know:

- The unit number with the split ports must be the default (stack-unit 0). You can verify this using the **show system brief** command. If the unit ID is not 0, you must renumber it to 0 before the ports are split by using the **stackunit id renumber 0** command in EXEC mode.
- The quad port must be in a default configuration before you can split it into four 10G ports. The 40G port is lost in the configuration when you split the port, so be sure the port is also removed from other L2/L3 feature configurations.
- For the split-port change to take effect, you must reload the system after issuing the command. Save your configuration.

## Powering Up the S4820T Switch

Supply power to the S4820T after it is mounted in a rack or cabinet.

Dell Force10 recommends re-inspecting your system prior to powering up. Verify that:

- Equipment is properly secured to the rack and properly grounded.
- Equipment rack is properly mounted and grounded.
- Ambient temperature around the unit (which may be higher than the room temperature) is within the limits specified for the S4820T.
- There is sufficient airflow around the S4820T unit.
- Input circuits are correctly sized for the loads and that you are using sufficient over-current protection devices.
- All protective covers on the S4820T are in place.
- Blank panels are installed over all openings in the S4820T chassis that would have contained optional modules.

### Power Up Sequence

When the system powers up, the fans immediately come on at high speed. The fan speed slows as the system continues to boot up.

The PWR LED blinks until the boot-up sequence is complete. When boot up is complete, the PWD LED becomes steadily lit.



## Connecting the Stacking Ports (Optional)

Before you make your stacking port connections, rack-mount the systems or insert them into a cabinet. To connect the stacking ports, insert one end of the cable into a configured port and insert the other end of the cable into a similarly configured port of the adjacent system.

**NOTE:** The maximum number of S4820T switches that can be stacked together is six.

There are no unique stacking ports; you can configure the RJ-45 and QSFP+ ports to act as stacking ports. The RJ-45 ports are labeled 0-47. The QSFP+ ports are labeled 48 and 56 for the lower QSFP+ ports and 52 and 60 for the upper QSFP+ ports.

**NOTE:** The S4820T system cannot be stacked with other S-Series systems.

**NOTE:** Data Center Bridging is not supported on the S4820T if ports 0 - 47 are being used for stacking.

### Important Port-Stacking Points to Know

When stacking the S4820T, keep the following in mind:

- Data ports are configured as stacking ports in predefined stacking groups of 40G (four 10G ports or one 40G port).
- When a stack-group number is assigned, the ports associated with that group are configured as stacking ports (Figure 4-7):
  - stack-group 0 = ports 0-3, stack-group 1 = ports 4-7, stack-group 2 = ports 8-11, and so on through stack-group 11 = ports 44-47.
  - stack-group 12 = port 48, stack-group 13 = port 52, stack-group 14 = port 56, stack-group 15 = port 60.
- All the ports in a stack-group are placed in stacking mode. You cannot use the unused ports in that group as data ports.

**Figure 4-7. S4820T Stack-Group Assignment**

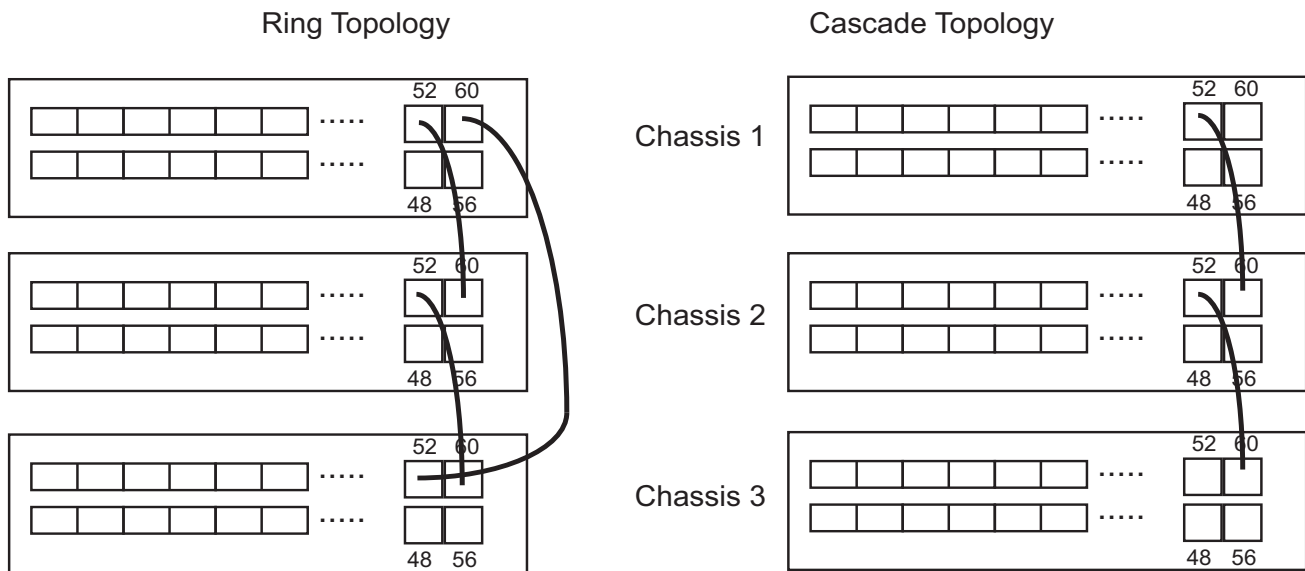

You can connect the systems while they are powered down or up. Stacking ports are bi-directional. The S4820T supports stacking in either a ring or a cascade topology (Figure 4-8). To provide redundant connectivity, Dell Force10 recommends using the ring topology when stacking S4820T systems.

**Figure 4-8. S4820T Stacking Topology**

## Connect Two S4820T Systems

To provide backup connectivity and increased data transfer between the systems, Dell Force10 recommends inserting an additional cable between the two units, in a second stacking port, as shown in [Figure 4-9](#).

You can use any of the RJ-45 or QSFP+ ports for stacking, provided it is configured as a stacking port.

**CAUTION:** To connect S4820T systems, use only Dell Force10 supported stacking cables.

To connect two S4820T systems in a ring ([Figure 4-9](#)), starting with the S4820T at the bottom of the stack, follow these steps:

**NOTE:** The port numbers in the following procedure are examples only.

Step	Task
1	Insert one end of the first cable into stack port 60 in chassis 1 (bottom).
2	Insert the other end of the same cable into stack port 52 on chassis 2 (top).
3	Insert a second cable into stack port 56 on chassis 2 (top).
4	Insert the other end of the second cable into stack port 56 on chassis 1 (bottom).

**Figure 4-9. Two S4820T Systems Connected in a Ring**

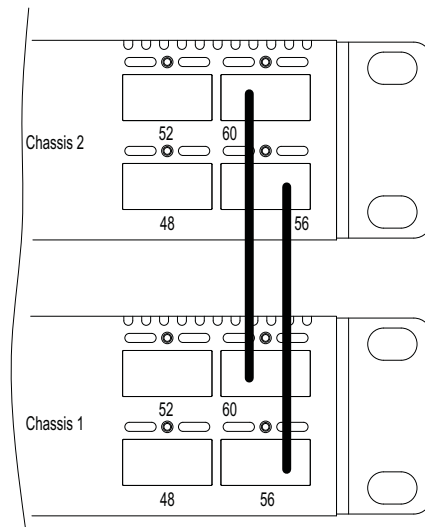

### Connect Three S4820T Systems

To provide backup connectivity and increased data transfer between the systems, Dell Force10 recommends inserting an additional cable between the two units, in a second stacking port, as shown in [Figure 4-10](#).

**CAUTION:** To connect S4820T systems, use only Dell Force10 supported stacking cables.

To connect three S4820T systems in a ring ([Figure 4-10](#)), starting with the S4820T at the bottom of the stack, follow these steps:

**NOTE:** The port numbers in the following procedure are used as examples only.

Step	Task
1	Insert one end of the first cable into stack port 60 of chassis 1 (bottom).
2	Insert the other end of the cable into stack port 52 of chassis 2 (center).
3	Insert the second cable into stack port 60 of chassis 2 (center) and port 52 the chassis 3 (top).
4	Use the third cable to connect the top and bottom units by inserting one end of the cable into stack port 56 on chassis 1 (bottom) and the other end of the cable into stack port 60 on chassis 3 (top).

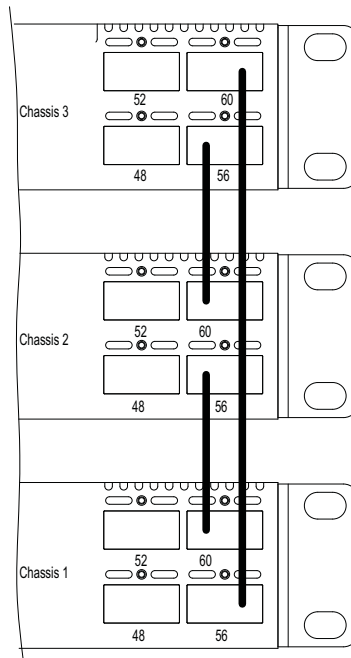
**Figure 4-10. Three S4820Ts Connected in a Ring**

### Hot-Swapping Units in a Stack

You can add, remove, or swap S4820T units in an existing stack. The units in the stack and the new units can be already powered up or powered down.

All units in a stack must run the same version of the operating system. If you attempt to attach a unit with a different version of the operating system to an existing stack, the CLI displays an error and the unit is not added until you install compatible software.

The order in which the units come on-line or are added to or removed from the stack affects how the stack identifies them and how the units identify themselves. This influences unit numbers, management addresses, and other elements of the configuration file.

Unit identification within the stack is determined by the identification algorithm you select. The default algorithm has the units self-identify as Unit 0 through Unit *last* based on the order in which they come on-line. So, when setting up a new set of switches in a stack, you should have no trouble forcing the identification of the management unit and unit IDs by methodically supplying power to the units in your preferred sequence.

Similarly, when you add a new unit to the stack, the unit is gracefully added as Unit *last* (the lowest unused number) with the current configuration. Attaching a new unit may cause each unit in the stack to reload. The subsequent configuration file in each unit includes the awareness of the new unit.

If you have a pre-configured unit that you want to add to the stack, but you want to make sure that the configuration does not override the configuration of the stack, add the unit while it is powered down to avoid stack management conflicts.

For more information about removing a unit from a stack and other stacking commands, refer to the Stacking chapter in the *FTOS Configuration Guide for the S4820T System* and the Stacking Commands chapter in the *FTOS Command Line Reference Guide for the S4820T System*.



## Power Supplies

The S4820T supports two hot-swappable power supplies units (PSUs) with integrated fans that provide cooling for the system. The S4820T supports AC power supplies with two air-flow directions (normal and reversed). Two PSUs are required for full redundancy, but the system will operate with a single PSU.

**NOTE:** If you use a single PSU, you must install a blank plate in the other PSU slot. Dell Force10 recommends using power supply 1 (PSU1) as the blank plate slot.

The PSUs are field replaceable. When running with full redundancy (two power supplies installed and running), you can remove and replace one PSU without disrupting traffic.

The S4820T does not support mixing PSU types. You cannot replace an AC PSU with a DC PSU and you cannot replace an AC-R PSU with a DC-R PSU.

**WARNING:** Electrostatic discharge (ESD) damage can occur if components are mishandled. Always wear an ESD-preventive wrist or heel ground strap when handling the S4820T and its components.

**CAUTION:** To prevent electrical shock, ensure the S4820T is grounded properly. If you do not ground your equipment correctly, excessive emissions may result. Use a qualified electrician to ensure the power cables meet your local electrical requirements.

## Components

The following power supply options are available for the S4820T:



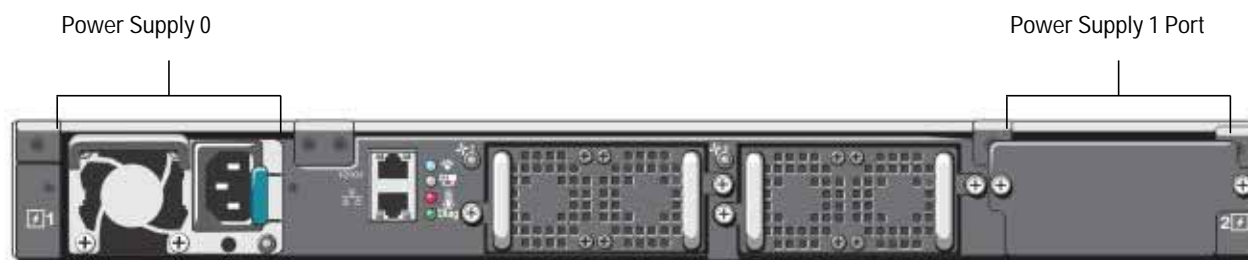

- AC power supply with integrated fan
- AC power supply with integrated reverse flow fan
- DC power supply with integrated fan
- DC power supply with integrated reverse flow fan

Power supply 0 (PSU0) is on the left side of the chassis; power supply 1 (PSU1) is on the right side of the chassis.

**Figure 5-1. S4820T with One AC PSU**





The PSUs are in a single piece with the PSU fans (see [Figure 5-1](#)). You can replace the fan trays individually, but you cannot replace the fans that are attached to the PSUs—if the fans attached to the PSU fail, you must replace the entire PSU. For fan tray replacement procedures, refer to [Chapter 6, Fans](#).

-  **WARNING:** Prevent exposure and contact with hazardous voltages. Do not attempt to operate this system with the safety cover removed.
-  **CAUTION:** Remove the power cable from the PSU prior to removing the PSU. Also, do not connect the power cable before you insert the PSU in the chassis.
-  **CAUTION:** The DC PSU comes with a 6-8 inch power cord with a snap-in plug that attaches to the DC power supply and screw terminals that attach to the main power. To ensure sufficient room, Dell Force10 recommends using a longer cable.
-  **CAUTION:** The power supply is marked + 48V -. Connect the + (plus sign) to the red cable on the 6-8 inch cord; connect the - (minus sign) to the black cable on the 6-8 inch cord. BE SURE TO connect the RED cable to RETURN and the BLACK cable to -48V.
-  **NOTE:** To comply with the GR-1089 Lightning Criteria for Equipment Interfacing with AC Power Ports, use an external SPD at the AC input of the router.

## Installing an AC or DC Power Supply



To install an AC or DC power supply, follow these steps:

-  **NOTE:** The PSU slides into the slot smoothly. Do not force a PSU into a slot as this may damage the PSU or the S4820T chassis.
-  **NOTE:** If you use a single PSU, you must install a blank plate in the other PSU slot. Dell Force10 recommends using power supply 1 (PSU1) as the blank plate slot.

Step	Task
1	Take the PSU out of the shipping box.
2	Use the grab handle to slide the PSU into the power supply bay.
3	Tighten the securing screw at the top of the PSU.
4	Attach the power cables.

-  **NOTE:** The S4820T powers up as soon as the cables are connected between the power supply and the power source.

## Replacing an AC or DC Power Supply

-  **NOTE:** The PSU slides into the slot smoothly. Do not force a PSU into a slot as this may damage the PSU or the S4820T chassis.
-  **NOTE:** If a PSU fails, you must completely replace it. There are no field servicable components in the PSU. To request a hardware replacement, refer to [Chapter 9, Technical Support](#).
-  **NOTE:** If you use a single PSU, you must install a blank plate in the other PSU slot. Dell Force10 recommends using power supply 1 (PSU1) as the blank plate slot.



To replace an AC or DC power supply, follow these steps:

Step	Task
1	Disconnect the power cable from the PSU.
2	Loosen the securing screws on the PSU with a screwdriver. Ensure that the PSU is loose and can be easily removed.
3	Use the grab handle to slide the PSU out of the power supply bay.
4	Use the grab handle on the replacement PSU to slide the PSU into the power supply bay.
5	Tighten the securing screws on the replacement PSU with a screwdriver. Ensure that the PSU is secure.
6	Attach the power cord to the replacement PSU.

**WARNING:** The S4820T powers up as soon as the cables are connected between the power supply and the power source.

## Connecting a DC Power Supply to the Power Source

Each DC powered S4820T comes with a set containing a pre-wired (3-inch 8AWG) power supply connector and a four-screw wiring block. One set is provided for each DC PSU (See [Figure 5-2](#)).

**Figure 5-2. DC Power Connector and Wiring Block**

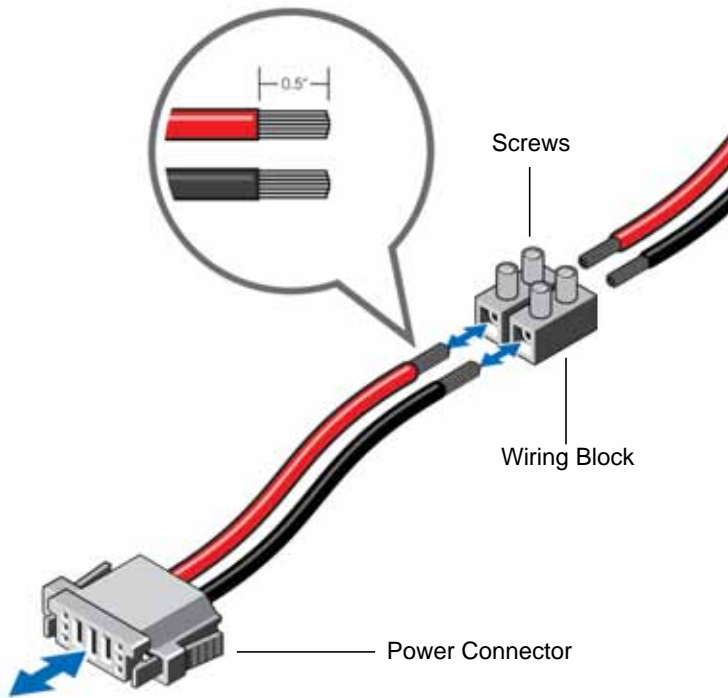

To connect a S4820T DC PSU to the site's DC power source, follow these steps:

Step	Task
1	Strip 1/2" of insulation from each of the power connector's wires (red and black, See <a href="#">Figure 5-2</a> ).
2	Insert each of the power connector's bare wire lengths into the wiring block (See <a href="#">Figure 5-2</a> ). Red into one hole and black into the other hole.
3	Use a flat-blade screwdriver to tighten the screws, which secures the bare wires into the wiring block.
4	Secure the site's DC power source wires to the other side of the wiring block (See steps 1 and 3).
	<b>⚠ WARNING:</b> Make sure not to cross the wires—In the wiring block, red should align with red and black should align with black (See <a href="#">Figure 5-2</a> ).
5	Insert the DC power connector into the power socket of the S4820T DC PSU. Make sure that you feel the connector pins firmly seat and you hear the click of the power connector's left and right levered clamps lock into place.
	<b>⚠ WARNING:</b> Never try to force the power connector into or out of the DC PSU power socket.

### Removing Power Connector from an S4820T DC Power Supply

To remove the power connector from an S4820T DC PSU, squeeze together the levers on both sides of the connector. Doing so disengages the power connector's clamps. While continuing to squeeze, pull the power connector from the DC PSU socket.

## Fans

The S4820T comes from the factory with one power supply unit (PSU) and two fan modules installed in the chassis (see [Figure 6-1](#)). The fan modules and the integrated fan-power supply are hot-swappable.

**NOTE:** To run the system, both slots must have operating fan units. If a module is not installed in each slot (either as part of the PSU or as an independent fan module), the system shuts down in one minute.

In addition to the integrated fan/power supply modules, you can order and install fan modules separately.

The S4820T supports two airflow direction options. Do not mix airflow types in a chassis; you can use only a single airflow direction in a chassis. If the airflow directions are mismatched, the S4820T powers down in one minute.

- Normal—airflow is from the I/O panel to the PSU
- Reversed—airflow is from the PSU to the I/O panel

Environmental factors can decrease the amount of time required between fan replacements. Check the environmental factors regularly. An increase in temperature and/or particulate matter in the air might affect performance (for example, new equipment installation).

**CAUTION:** Check the fans at six-month intervals and replace them as necessary. Regularly monitor the speeds of the cooling fans in order to accurately determine replacement intervals.

## Components

- S4820T Fan module
- S4820T Fan module - Reverse flow

**Figure 6-1. S4820T Fan Modules and One AC PSU**

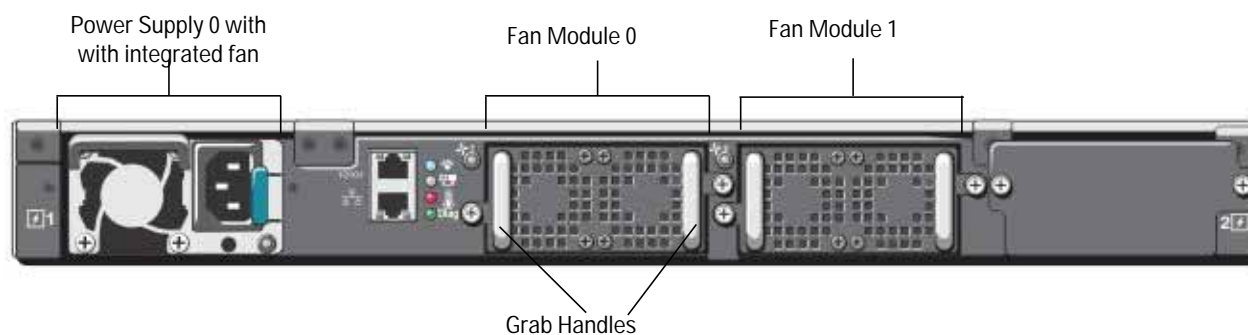

## Install a Fan Module



**CAUTION:** DO NOT mix airflow directions. Both fans must use the same airflow direction (reverse or normal). If the airflows are mismatched, an error message appears and the system shuts down.

```
00:02:19:%S4820T:0%CHMGR-2-PSU_TYPE_AIRFLOW_MISMATCH: Mismatching PSU airflow detected. Unit 0 shall get shutdown in next 60 seconds if mismatch not rectified.
```

```
00:02:19:%STKUNIT0-M:CP%CHMGR-1-PSU_AIRFLOW_COMBO_MISMATCH: Major alarm: Mismatching PSU airflow detected in unit 0
```

The fan modules in the S4820T are field replaceable. Module slot 0 is on the left side of the chassis; module slot 1 is on the right side of the chassis.

To install a fan module, follow these steps:

Step	Task
1	Take the fan module out of the shipping box.
2	Use the grab handle to slide the fan module into the bay.
3	Tighten the securing screws on the sides of the fan module.

## Replace a Fan Module

To replace a fan module, follow these steps:

Step	Task
1	Loosen the securing screws on the sides of the fan module.
	<b>CAUTION:</b> You must complete steps 2 and 3 within one minute or the system powers down.
2	Use the grab handle to slide the fan module out of the bay.
3	Use the grab handle on the replacement module to slide it into the bay.
4	Tighten the captive screws on the replacement module with a screwdriver. Ensure the module is secure.

## Management Ports

Besides the 10 Gigabit and 40 Gigabit switch ports, the S4820T provides several ports for management and storage.

### Accessing the RJ-45 Console Port (RS-232)

- ✎ **NOTE:** Before starting this procedure, be sure that your PC has a 9-pin serial port and that you have a terminal emulation program already installed and running on the PC.
- ✎ **NOTE:** If your PC's serial port cannot accept a female DB-9 connector, you need to acquire a DB-9 male-to-male adaptor.

The RS-232/RJ-45 console port is located (and labeled) on the PSU-side of the S4820T chassis (see [Figure 7-1](#)).

**Figure 7-1. Location of Console Port**

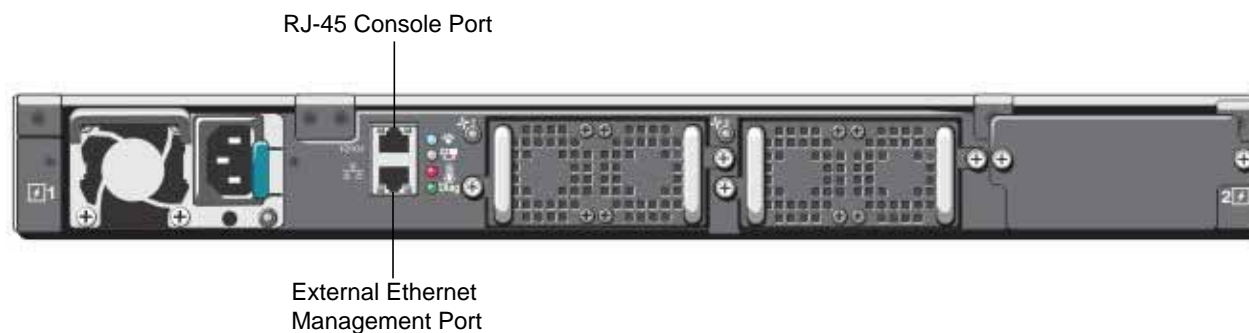

To access the console port, follow these steps:

Step	Task
1	Install the provided RJ-45 connector side of the provided copper cable into the S4820T console port.
2	Install the DB-9 female side of the provided copper cable into your PC's serial port (or into other DTE terminal server hardware that you intend to use).
3	Keep the default terminal settings on the S4820T console as follows: <ul style="list-style-type: none"> <li>• 9600 baud rate</li> <li>• No parity</li> <li>• 8 data bits</li> <li>• 1 stop bit</li> <li>• No flow control</li> </ul>

## Default Configuration

A version of FTOS is pre-loaded onto the S4820T switch; however, the switch is not configured when you power it up for the first time (except for the default host name, which is FTOS). You must configure the switch using the CLI.

# Specifications

This chapter contains the following sections:

- [Chassis Physical Design](#)
- [Environmental Parameters](#)
- [Power Requirements](#)
- [IEEE Standards](#)
- [Agency Compliance](#)

△ **Caution:** Operate the product at an ambient temperature not higher than 113°C.

△ **Lithium Battery Caution:** There is a danger of explosion if the battery is incorrectly replaced. Replace only with same or equivalent type. Dispose of the batteries according to the manufacturer's instructions.

## Chassis Physical Design

Parameter	Specifications
Height	1.71 inches (43.5 mm)
Width	17.09 inches (434 mm)
Depth	18.11 inches (460 mm)
Weight	21.7 lbs (9.86 kg)

## Environmental Parameters

Parameter	Specifications
Operating temperature	32° to 113°F (0° to 45°C)
Operating humidity	5 to 90% (RH), non-condensing
Storage temperature	-40° to 158°F (-40° to 70°C)
Storage humidity	5 to 95% (RH), non-condensing
Maximum thermal output	1153.265 BTU/hr

## Power Requirements

The tables below represents the PSU's capabilities and does not represent the S4820T's operation.

### AC Input Specification

Parameter	Specifications
Power supply	100–240 VAC 50/60 Hz
Maximum current draw per system	5.8 A @ 398.02watts/100vac 2.9 A @ 398.02watts/200vac
Maximum power consumption	460 Watts (AC)
Maximum power consumption	800 Watts (DC)
Typical power consumption	338 Watts
Reliability	MTBF 355,178 hours

### DC Input Specification.

<b>min/max input voltage range</b>	-40.5V /-48V/ -60V
<b>input power at full load</b>	-40.5V/970W -48V/930W -60V/ 950W (without fan) -40.5V/980W -48V/940W -60V/ 960W (with fan)
<b>input current at full load</b>	-40.5V/23.8A -48V/19.0A -60V/ 15.6A (without fan) -40.5V/24A -48V/19.2A -60V/ 16.0A (with fan)
<b>Start up VDC</b>	39.0+/-1.5V
<b>Start off VDC</b>	37.5+/-1.5V

## IEEE Standards

The S4820T switch complies with the following IEEE standards:

- 802.1AB LLDP
- 802.1ag Connectivity fault Management
- 802.1D Bridging, STP
- 802.1p L2 Prioritization
- 802.1Q VLAN Tagging, Double VLAN Tagging, GVRP
- 802.1s MSTP
- 802.1w RSTP
- 802.3ab Gigabit Ethernet (1000BASE-T)
- 802.3ac Frame Extensions for VLAN Tagging



- 802.3ad Link Aggregation with LACP
- 802.3ae 10 Gigabit Ethernet (10GBASE-X)
- 802.3ba 40 Gigabit Ethernet (40GBase-SR4, 40GBase-CR4) on optical ports
- 802.3u Fast Ethernet (100BASE-TX)
- 802.3x Flow Control
- 802.3z Gigabit Ethernet (1000BASE-X)
- ANSI/TIA-1057 (LLDP-MED)
- Force10 (PVST+)
- MTU (12,000 bytes)

## Agency Compliance

### Network Equipment Building Systems (NEBS) Compliance

- Use shielded cables for ports 0 - 48. You must ground the shields at both ends.
- Use only reverse airflow configurations in a NEBS-compliant installation.
- Fit the power supplies and fan modules with filter kits. You must replace the fan filters on a regular basis.
- Use this equipment with an external, second-level 6kV lightning Surge Protective Device (SPD) at the AC input of the building.
- Use a SPD with the AC power connections in order to protect the AC power supplies from damage from excessive power line surges.
- In order to comply with the GR-1089 Lightning Criteria for Equipment Interfacing with AC Power Ports, use a SPD at the AC input of the router.

 **WARNING:** Electrostatic discharge (ESD) damage can occur if components are mishandled. Always wear an ESD-preventive wrist or heel ground strap when handling the S4820T and its components.

### USA Federal Communications Commission (FCC) Statement

This equipment has been tested and found to comply with the limits for a Class A digital device, pursuant to Part 15 of the FCC rules. These limits are designated to provide reasonable protection against harmful interference when the equipment is operated in a commercial environment. This equipment generates, uses, and can radiate radio frequency energy. If it is not installed and used in accordance to the instructions, it may cause harmful interference to radio communications. Operation of this equipment in a residential area is likely to cause harmful interference, in which case users will be required to take whatever measures necessary to correct the interference at their own expense.

Properly shielded and grounded cables and connectors must be used in order to meet FCC emission limits. Dell Force10 is not responsible for any radio or television interference caused by using other than recommended cables and connectors or by unauthorized changes or modifications in the equipment. Unauthorized changes or modification could void the user's authority to operate the equipment.

This device complies with Part 15 of the FCC Rules. Operation is subject to the following two conditions: (1) this device may not cause harmful interference, and (2) this device must accept any interference received, including interference that may cause undesired operation.

## Canadian Department of Communication Statement

### Industry Canada Class A emission compliance statement

This Class A digital apparatus complies with Canadian ICES-003.

### Avis de conformité à la réglementation d'Industrie Canada

Cet appareil numérique de la classe A est conforme à la norme NMB-003 du Canada.

## European Union EMC Directive Conformance Statement

This product is in conformity with the protection requirements of EU Council Directive 2004/108/EC on the approximation of the laws of the Member States relating to electromagnetic compatibility. Force 10 Networks can not accept responsibility for any failure to satisfy the protection requirements resulting from a non-recommended modification of this product, including the fitting of non-Dell Force10 option cards.

This product has been tested and found to comply with the limits for Class A Information Technology Equipment according to CISPR 22/European Standard EN 55022. The limits for Class A equipment were derived for commercial and industrial environments to provide reasonable protection against interference with licensed communication equipment.

**⚠ WARNING:** This is a Class A product. In a domestic environment, this device may cause radio interference, in which case, you may be required to take adequate measures.

European Community Contact  
Dell Force10, EMEA - Central  
Dahlienweg 19  
66265 Heusweiler  
Germany

<http://www.force10networks.com/german/>

Tel: +49 172 6802630

Email: EMEA Central Sales

## Japan: VCCI Compliance for Class A Equipment

この装置は、情報処理装置等電波障害自主規制協議会（VCCI）の基準に基づくクラスA情報技術装置です。この装置を家庭環境で使用すると電波妨害を引き起こすことがあります。この場合には使用者が適切な対策を講ずるよう要求されることがあります。

This is Class A product based on the standard of the Voluntary Control Council For Interference by Information Technology Equipment (VCCI). If this equipment is used in a domestic environment, radio disturbance may arise. When such trouble occurs, the user may be required to take corrective actions.

**⚠ WARNING:** Use the AC power cords with Dell Force10 equipment only. Do not use Dell Force10 AC power cords with any unauthorized hardware.

本製品に同梱いたしております電源コードセットは、本製品専用です。本電源コードセットは、本製品以外の製品ならびに他の用途でご使用いただくことは出来ません。製品本体には同梱された電源コードセットを使用し、他製品の電源コードセットを使用しないで下さい。

## Korean Certification of Compliance

A급 기기 (업무용 방송통신기자재)	이 기기는 업무용(A급) 전자파적합기기로서 판매자 또는 사용자는 이 점을 주의하시기 바라며, 가정외의 지역에서 사용하는 것을 목적으로 합니다.
------------------------	---

### Korean Package Label

	 <i>[equipment type]</i>
품명(Product Name)	Ethernet Switch
모델명(Model)	<i>[model number]</i>
신청인(Applicant)	Force10 Networks, Inc.
제조사(Manufacturer)	Delta Networks, (Dongguan) Ltd.
제조년월(Manufacturing Date)	<i>[date]</i>
제조국(Country of Origin)	China

## Safety Standards and Compliance Agency Certifications

- CUS UL 60950-1, 2nd Edition
- CSA 60950-1-03, 2nd Edition

- EN 60950-1, 2nd Edition
- EN 60825-1, 1st Edition
- EN 60825-1 Safety of Laser Products—Part 1: Equipment Classification Requirements and User's Guide
- EN 60825-2 Safety of Laser Products—Part 2: Safety of Optical Fibre Communication Systems
- FDA Regulation 21CFR 1040.10 and 1040.11
- IEC 60950-1, 2nd Ed, including all National Deviations and Group Differences

## **Electromagnetic Compatibility (EMC)**

### Emissions

- International: CISPR 22: 2006, Class A
- Australia/New Zealand: AS/NZS CISPR 22:2009, Class A
- Canada: ICES-003, Issue-4, Class A
- Europe: EN55022 2006 (CISPR 22: 2006), Class A
- Japan: VCCI V-3/2011.04 Class A
- USA: FCC CFR47 Part 15, Subpart B, Class A

### Immunity

- EN 300 386 v1.5.1:2010 EMC for Network Equipment
- EN55022 2006, Class A
- EN 55024 1998 + A1: 2001 + A2: 2003
- EN 61000-3-2 Harmonic Current Emissions
- EN 61000-3-3 Voltage Fluctuations and Flicker
- EN 61000-4-2 ESD
- EN 61000-4-3 Radiated Immunity
- EN 61000-4-4 EFT
- EN 61000-4-5 Surge
- EN 61000-4-6 Low Frequency Conducted Immunity

## **Product Recycling and Disposal**

You must recycle or discard this system according to applicable local and national regulations. Dell Force10 encourages owners of information technology (IT) equipment to responsibly recycle their equipment when it is no longer needed. Dell Force10 offers a variety of product return programs and services in several countries to assist equipment owners in recycling their IT products.

Waste Electrical and Electronic Equipment (WEEE) Directive for Recovery, Recycle and Reuse of IT and Telecommunications Products

Dell Force10 switches are labeled in accordance with European Directive 2002/96/EC concerning waste electrical and electronic equipment (WEEE). The Directive determines the framework for the return and recycling of used appliances as applicable throughout the European Union. This label is applied to various products to indicate that the product is not to be thrown away, but rather reclaimed upon end of life per this Directive.

**Figure 8-1. The European WEEE symbol**



In accordance with the European WEEE Directive, electrical and electronic equipment (EEE) is to be collected separately and to be reused, recycled, or recovered at end of life. Users of EEE with the WEEE marking per Annex IV of the WEEE Directive, as shown above, must not dispose of end of life EEE as unsorted municipal waste, but use the collection framework available to customers for the return, recycling and recovery of WEEE. Customer participation is important to minimize any potential effects of EEE on the environment and human health due to the potential presence of hazardous substances in EEE.

Dell Force10 products, which fall within the scope of the WEEE, are labeled with the crossed-out wheeled-bin symbol, as shown above, as required by WEEE.

For information on Dell Force10 product recycling offerings, see the WEEE Recycling instructions on iSupport at: <https://www.force10networks.com/CSPortal20/Support/WEEEandRecycling.pdf>. For more information, contact the Dell Force10 Technical Assistance Center (TAC) (see [Contacting the Technical Assistance Center](#)).



# Technical Support

This chapter contains the following sections:

- [The iSupport Website](#)
- [Contacting the Technical Assistance Center](#)
- [Requesting a Hardware Replacement](#)

## The iSupport Website

iSupport provides a range of documents and tools to assist you with effectively using Dell Force10 equipment and mitigating the impact of network outages. Through iSupport you can obtain technical information regarding Dell Force10 products, access to software upgrades and patches, and open and manage your Technical Assistance Center (TAC) cases. Dell Force10 iSupport provides integrated, secure access to these services.

### Accessing iSupport Services

The URL for iSupport is <http://www.force10networks.com/support/>. You must have a userid and password to access iSupport services.

To request a userid and password, follow these steps:

Step	Task
1	On the Dell Force10 Support page, click the <b>Account Request</b> link.
2	Fill out the User Account Request form and click <b>Send</b> . You will receive your userid and password by E-mail.
3	To access iSupport services, click the <b>LOGIN</b> link and enter your userid and password.

# Contacting the Technical Assistance Center

<b>How to Contact Dell Force10 TAC</b>	Log in to iSupport at <a href="http://www.force10networks.com/support/">http://www.force10networks.com/support/</a> and select the <b>Service Request</b> tab.
<b>Information to Submit When Opening a Support Case</b>	<ul style="list-style-type: none"> <li>• Your name, company name, phone number, and E-mail address</li> <li>• Preferred method of contact</li> <li>• Model number</li> <li>• Software version number</li> <li>• Symptom description</li> <li>• Screen shots showing the symptom, including any error messages. This can include:             <ul style="list-style-type: none"> <li>• Output from the <b>show tech-support [non-paged]</b> command (This report is very long so set the storage buffer in your terminal program to high.)</li> <li>• Output from the <b>show logging eventlog [unit]</b> command, where unit is the stack ID of the member unit that experienced the failure (This report is included as a section in the output of the <b>show tech-support [non-paged]</b> command.)</li> <li>• Console captures showing the error messages</li> <li>• Console captures showing the troubleshooting steps taken</li> <li>• Saved messages to a syslog server, if you use one</li> </ul> </li> </ul>
<b>Managing Your Case</b>	Log in to iSupport and select the <b>Service Request</b> tab to view all open cases and Return Materials Authorizations (RMAs).
<b>Downloading Software Updates</b>	Log in to iSupport and select the <b>Software Center</b> tab.
<b>Technical Documentation</b>	Log in to iSupport and select the <b>Documents</b> tab. You can access this page without logging in using the <b>Documentation</b> link on the iSupport page.
<b>Contact Information</b>	<p>E-mail: <a href="mailto:support@force10networks.com">support@force10networks.com</a></p> <p>Web: <a href="http://www.force10networks.com/support/">http://www.force10networks.com/support/</a>.</p> <p>Telephone:</p> <ul style="list-style-type: none"> <li>• US and Canada: 866.965.5800</li> <li>• International: 408.965.5800</li> </ul>



# Requesting a Hardware Replacement

To request replacement hardware, follow these steps:

Step	Task
1	Determine the part number and serial number of the component. To list the numbers for all components installed in the chassis, use the <b>show hardware</b> command.
2	Request an RMA number from TAC by opening a support case. Open a support case by: <ul style="list-style-type: none"><li>• Using the Create Service Request form on the iSupport page (see <a href="#">Contacting the Technical Assistance Center</a>).</li><li>• Contacting Dell Force10 directly by E-mail or by phone (see <a href="#">Contacting the Technical Assistance Center</a>). Provide the following information when using E-mail or phone:<ul style="list-style-type: none"><li>• Part number, description, and serial number of the component.</li><li>• Your name, organization name, telephone number, fax number, and E-mail address.</li><li>• Shipping address for the replacement component, including a contact name, phone number, and E-mail address.</li><li>• A description of the failure, including log messages. This can include:<ul style="list-style-type: none"><li>– Output from the <b>show tech-support [non-paged]</b> command (This report is very long so set the storage buffer in your terminal program to high.)</li><li>– Output from the <b>show logging eventlog [unit]</b> command, where unit is the stack ID of the member unit that experienced the failure (This report is included as a section in the output of <b>show tech-support [non-paged]</b> command.)</li><li>– Console captures showing the error messages</li><li>– Console captures showing the troubleshooting steps taken</li><li>– Saved messages to a syslog server, if you use one</li></ul></li></ul></li></ul>







Printed in the U.S.A.

[www.dell.com](http://www.dell.com) | [support.dell.com](http://support.dell.com)